

Stelline ST-10-HB

Flexible LED striplights for exterior or interior applications. Available in a multitude of sizes and bend directions.

Fully customisable, supplied cut to length and factory sealed, Stelline is available with White, RGB, RGBW, Dynamic White or Dim to Warm LED's to suit your exact requirements. Feed cables can be supplied protruding from the end, side or bottom of the strip and are available in pre-cut lengths of up to 10,000mm. Suitable for the harshest installation environments, Stelline is saltwater, UV, flame and solvent resistant with an operating temperature range of -40 °C - +55 °C and IK08 impact rating.

Bottom Cable Entry



End Cable Entry

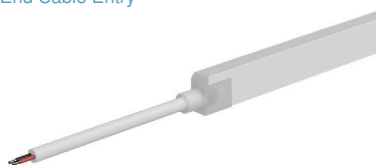

Side Cable Entry



End Cap

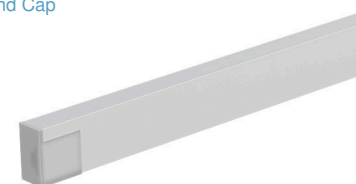

Anti-Wicking Ferrule

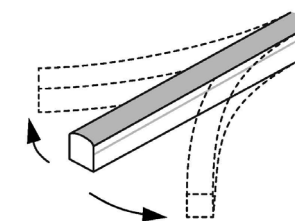

Format	Dimensions	Voltage	Wattage	Colour Temperature	Output	IP Rating	Temperature Range	Max Length	Cut Increment	Min Bend Radius
ST-10-HB-White	18mm x 9mm	24V	4.5W/m	2700K / 3000K / 4000K	130 lm/m	67	-40°C - +55°C	30m	83.34mm	45mm

All fittings will require a 24VDC constant voltage driver.

Stelline ST-15-HB

Flexible LED striplights for exterior or interior applications. Available in a multitude of sizes and bend directions.

Fully customisable, supplied cut to length and factory sealed, Stelline is available with White, RGB, RGBW, Dynamic White or Dim to Warm LED's to suit your exact requirements. Feed cables can be supplied protruding from the end, side or bottom of the strip and are available in pre-cut lengths of up to 10,000mm. Suitable for the harshest installation environments, Stelline is saltwater, UV, flame and solvent resistant with an operating temperature range of -40 °C - +55 °C and IK08 impact rating.

Bottom Cable Entry



End Cap



End Cable Entry



Anti-Wicking Ferrule



Side Cable Entry

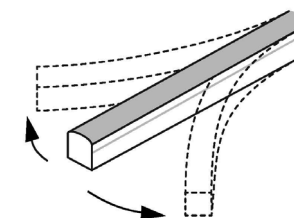

Format	Dimensions	Voltage	Wattage	Colour Temperature	Output	IP Rating	Temperature Range	Max Length	Cut Increment	Min Bend Radius
ST-15-HB-White	21mm x 11.5mm	24V	12W/m	2700K / 3000K / 4000K	400 lm/m	67	-40°C - +55°C	15m	83.34mm	60mm
ST-15-HB-RGB	21mm x 11.5mm	24V	12W/m	N/A	N/A	67	-40°C - +55°C	10m	100mm	60mm
ST-15-HB-RGBW	21mm x 11.5mm	24V	15W/m	2700K / 4000K	120 lm/m	67	-40°C - +55°C	8m	100mm	60mm
ST-15-HB-Dynamic White	21mm x 11.5mm	24V	12W/m	2200K - 5700K	140 lm/m - 170 lm/m	67	-40°C - +55°C	15m	83.34mm	60mm
ST-15-HB-Dim to Warm	21mm x 11.5mm	24V	12W/m	1800K - 3000K	2 lm/m - 340 lm/m	67	-40°C - +55°C	15m	83.34mm	60mm
ST-15-HB-White (Sauna)	21mm x 11.5mm	24V	6W/m	2700K / 3000K / 4000K	200 lm/m	67	-40°C - +90°C	10m	83.34mm	60mm

All fittings will require a 24VDC constant voltage driver.

Stelline ST-22-HB

Flexible LED striplights for exterior or interior applications. Available in a multitude of sizes and bend directions.

Fully customisable, supplied cut to length and factory sealed, Stelline is available with White, RGB, RGBW, Dynamic White or Dim to Warm LED's to suit your exact requirements. Feed cables can be supplied protruding from the end, side or bottom of the strip and are available in pre-cut lengths of up to 10,000mm. Suitable for the harshest installation environments, Stelline is saltwater, UV, flame and solvent resistant with an operating temperature range of -40 °C - +55 °C and IK08 impact rating.

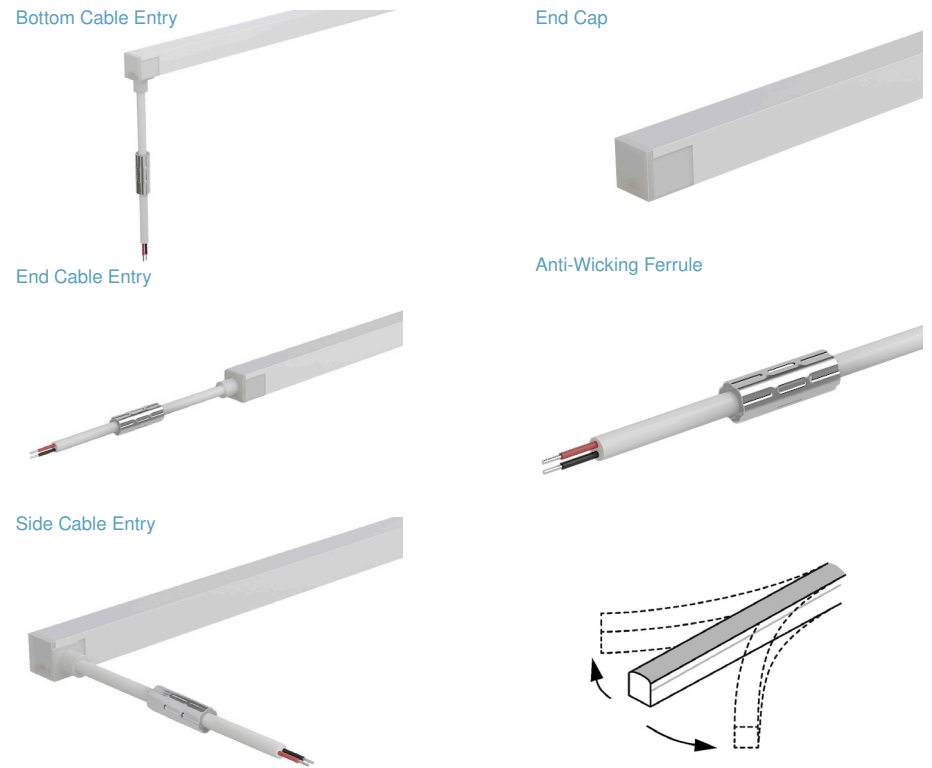

Format	Dimensions	Voltage	Wattage	Colour Temperature	Output	IP Rating	Temperature Range	Max Length	Cut Increment	Min Bend Radius
ST-22-HB-White	17mm x 16mm	24V	12W/m	2700K / 3000K / 4000K	470 lm/m	67	-40°C - +55°C	15m	55.56mm	150mm
ST-22-HB-White (High Power)	17mm x 16mm	24V	15W/m	2700K / 3000K / 4000K	800 lm/m	67	-40°C - +45°C	10m	55.56mm	150mm
ST-22-VB-White (Short Cutting)	17mm x 16mm	24V	12W/m	2700K / 3000K / 4000K	440 lm/m	67	-40°C - +55°C	12m	18.52mm	150mm
ST-22-HB-RGB	17mm x 16mm	24V	12W/m	N/A	N/A	67	-40°C - +55°C	10m	83.34mm	150mm
ST-22-HB-Dynamic White	17mm x 16mm	24V	12W/m	2200K - 5700K	220 lm/m - 270 lm/m	67	-40°C - +55°C	15m	83.34mm	150mm
ST-22-HB-Dim to Warm	17mm x 16mm	24V	12W/m	1800K - 3000K	3 lm/m - 500 lm/m	67	-40°C - +55°C	15m	62.5mm	150mm
ST-22-HB-White (Sauna)	17mm x 16mm	24V	6W/m	2700K / 3000K / 4000K	235 lm/m	67	-40°C - +90°C	10m	55.56mm	150mm

All fittings will require a 24VDC constant voltage driver.

Stelline ST-22-VB

Flexible LED striplights for exterior or interior applications. Available in a multitude of sizes and bend directions.

Fully customisable, supplied cut to length and factory sealed, Stelline is available with White, RGB, RGBW, Dynamic White or Dim to Warm LED's to suit your exact requirements. Feed cables can be supplied protruding from the end, side or bottom of the strip and are available in pre-cut lengths of up to 10,000mm. Suitable for the harshest installation environments, Stelline is saltwater, UV, flame and solvent resistant with an operating temperature range of -40 °C - +55 °C and IK08 impact rating.

Bottom Cable Entry



End Cap



End Cable Entry



Anti-Wicking Ferrule



Side Cable Entry

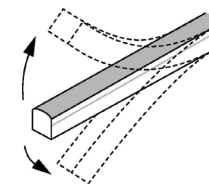

Format	Dimensions	Voltage	Wattage	Colour Temperature	Output	IP Rating	Temperature Range	Max Length	Cut Increment	Min Bend Radius
ST-22-VB-White	17mm x 16mm	24V	12W/m	2700K / 3000K / 4000K	560 lm/m	67	-40°C - +55°C	15m	55.56mm	150mm
ST-22-VB-White (High Power)	17mm x 16mm	24V	15W/m	2700K / 3000K / 4000K	800 lm/m	67	-40°C - +45°C	10m	55.56mm	150mm
ST-22-VB-White (Short Cutting)	17mm x 16mm	24V	12W/m	2700K / 3000K / 4000K	440 lm/m	67	-40°C - +55°C	12m	18.52mm	150mm
ST-22-VB-RGB	17mm x 16mm	24V	12W/m	N/A	N/A	67	-40°C - +55°C	10m	83.34mm	150mm
ST-22-VB-RGBW	17mm x 16mm	24V	15W/m	2700K / 4000K	200 lm/m	67	-40°C - +55°C	8m	83.34mm	150mm
ST-22-VB-Dynamic White	17mm x 16mm	24V	12W/m	2200K - 5700K	220 lm/m - 270 lm/m	67	-40°C - +55°C	15m	83.34mm	150mm
ST-22-VB-Dim to Warm	17mm x 16mm	24V	12W/m	1800K - 3000K	3 lm/m - 500 lm/m	67	-40°C - +55°C	15m	62.5mm	150mm
ST-22-VB-White (Sauna)	17mm x 16mm	24V	6W/m	2700K / 3000K / 4000K	280 lm/m	67	-40°C - +90°C	10m	55.56mm	150mm

All fittings will require a 24VDC constant voltage driver.

Stelline ST-23-HB

Flexible LED striplights for exterior or interior applications. Available in a multitude of sizes and bend directions.

Fully customisable, supplied cut to length and factory sealed, Stelline is available with White, RGB, RGBW, Dynamic White or Dim to Warm LED's to suit your exact requirements. Feed cables can be supplied protruding from the end, side or bottom of the strip and are available in pre-cut lengths of up to 10,000mm. Suitable for the harshest installation environments, Stelline is saltwater, UV, flame and solvent resistant with an operating temperature range of -40 °C - +55 °C and IK08 impact rating.

Bottom Cable Entry



End Cap

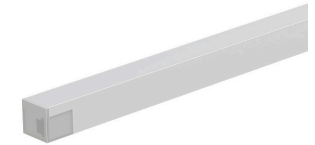

End Cable Entry

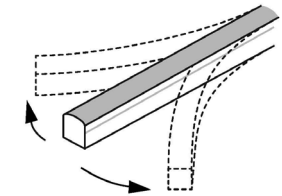

Side Cable Entry



Format	Dimensions	Voltage	Wattage	Colour Temperature	Output	IP Rating	Temperature Range	Max Length	Cut Increment	Min Bend Radius
ST-23-HB-White	10mm x 10mm	24V	4.5W/m	2700K / 3000K / 4000K	220 lm/m	67	-40°C - +55°C	15m	83.34mm	50mm
ST-23-HB-White (High Power)	10mm x 10mm	24V	9W/m	2700K / 3000K / 4000K	420 lm/m	67	-40°C - +45°C	7.5m	83.34mm	50mm

All fittings will require a 24VDC constant voltage driver.

Stelline ST-23-VB

Flexible LED striplights for exterior or interior applications. Available in a multitude of sizes and bend directions.

Fully customisable, supplied cut to length and factory sealed, Stelline is available with White, RGB, RGBW, Dynamic White or Dim to Warm LED's to suit your exact requirements. Feed cables can be supplied protruding from the end, side or bottom of the strip and are available in pre-cut lengths of up to 10,000mm. Suitable for the harshest installation environments, Stelline is saltwater, UV, flame and solvent resistant with an operating temperature range of -40 °C - +55 °C and IK08 impact rating.

Bottom Cable Entry



End Cap



End Cable Entry

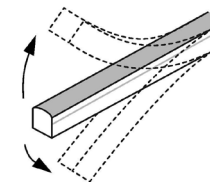

Side Cable Entry



Format	Dimensions	Voltage	Wattage	Colour Temperature	Output	IP Rating	Temperature Range	Max Length	Cut Increment	Min Bend Radius
ST-23-VB-White	10mm x 10mm	24V	4.5W/m	2700K / 3000K / 4000K	220 lm/m	67	-40°C - +55°C	15m	83.34mm	50mm
ST-23-VB-White (High Power)	10mm x 10mm	24V	9W/m	2700K / 3000K / 4000K	440 lm/m	67	-40°C - +45°C	7.5m	83.34mm	50mm

All fittings will require a 24VDC constant voltage driver.

Stelline Feed Cable Options

Horizontal Bending



Vertical Bending

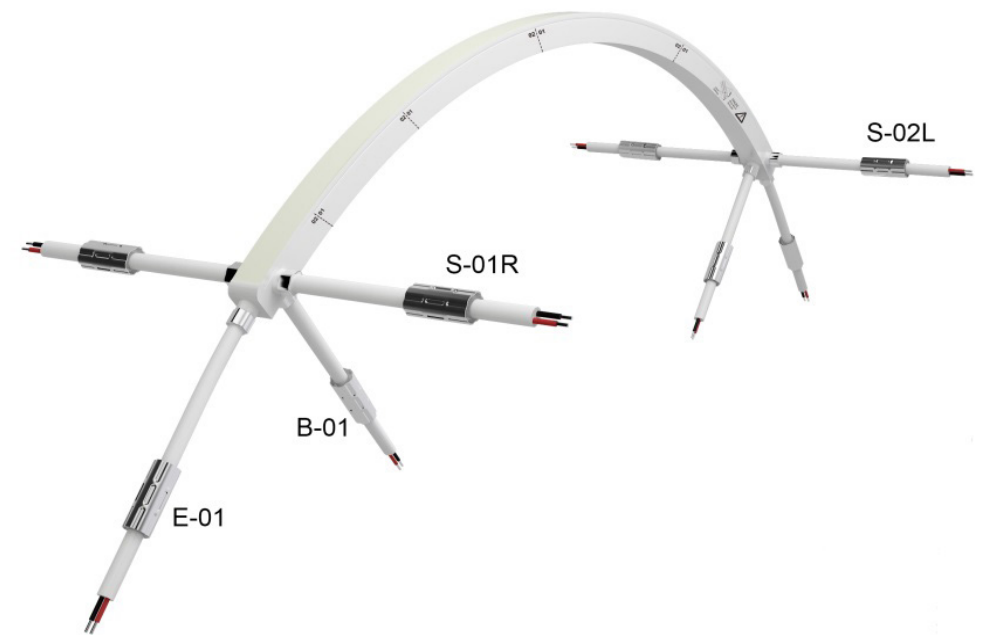

Stelline ST-2010-VB

Flexible LED striplights for use in potentially explosive atmospheres.

Stelline ST-2010-VB uses “encapsulation” methods to achieve Ex certification. The silicone material is saltwater, UV, flame and solvent resistant with an operating temperature range of -30 °C - +40°C making it perfect for hazardous marine areas such as helicopter re-fuelling bays and tender bays.

Supplied cut to length and factory sealed, Stelline ST-2010-VB is supplied with 6500K “daylight” White LED’s and injection moulded feed cables with customisable feed cable lengths.

End Cable Entry

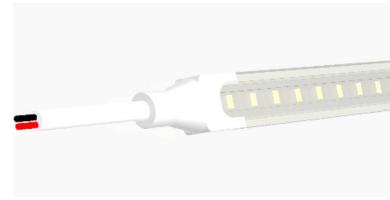

End Cap

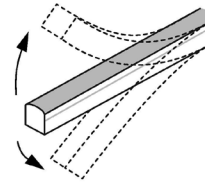
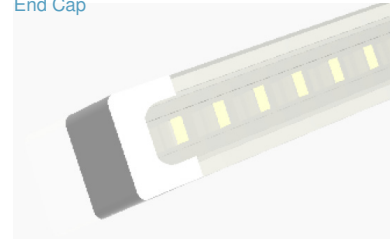

Format	Dimensions	Voltage	Wattage	Colour Temperature	Output	IP Rating	Temperature Range	Max Length	Cut Increment	Min Bend Radius
ST-2010-VB	10mm x 20mm	24V	12W/m	6500K	1000 lm/m	67	-30°C - +40°C	15m	83mm	150mm

All fittings will require a 24VDC constant voltage driver.



Stelline ST-10 Mounting Profiles

ST-10 Serrated Aluminium Mounting Profile

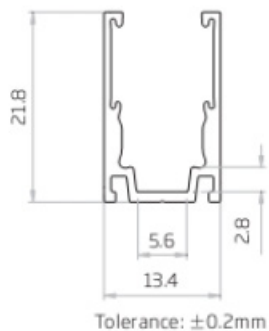

20mm
500mm
1,000mm
2,000mm

ST-10 Bendable Serrated Aluminium Mounting Profile

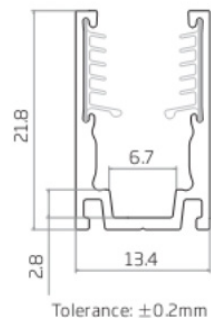
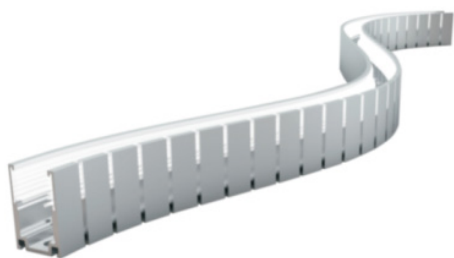

500mm
1,000mm

ST-10 Plastic Mounting Profile

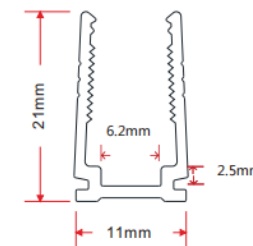

500mm
1,000mm
2,000mm

Stelline ST-15 Mounting Profiles

ST-15 Serrated Aluminium Mounting Profile

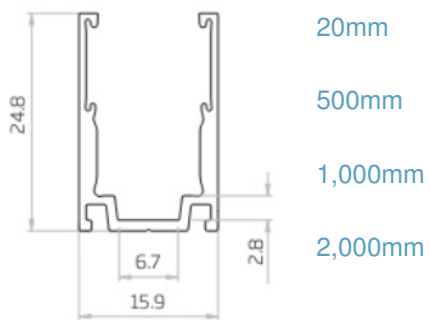

ST-15 Bendable Serrated Aluminium Mounting Profile

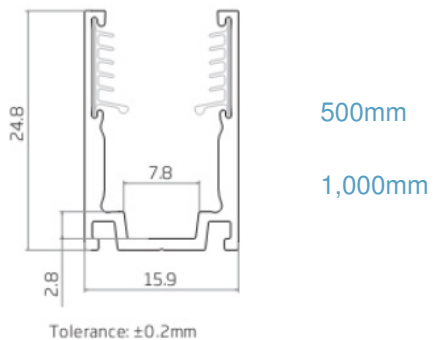
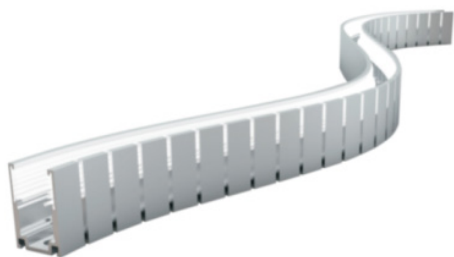

ST-15 Plastic Mounting Profile

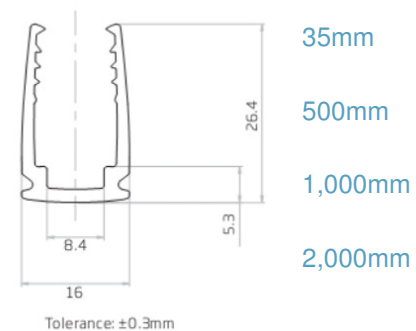

Stelline ST-22 Mounting Profiles

ST-22 Serrated Aluminium Mounting Profile

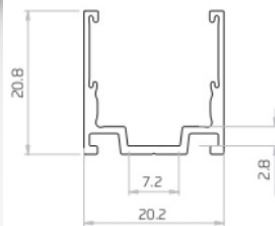
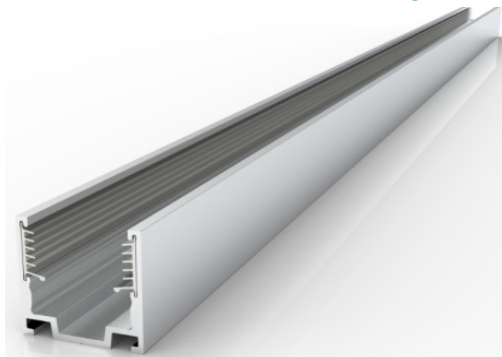

Tolerance: $\pm 0.2\text{mm}$

- 20mm
- 500mm
- 1,000mm
- 2,000mm

ST-22 Bendable Serrated Aluminium Mounting Profile

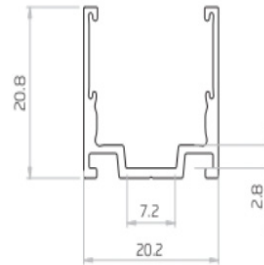
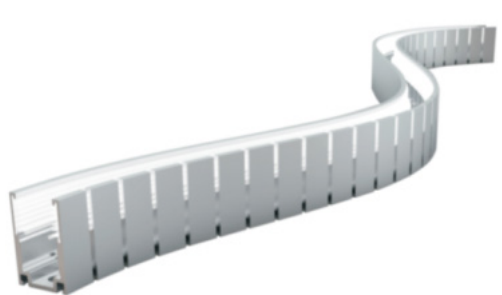

Tolerance: $\pm 0.2\text{mm}$

- 500mm
- 1,000mm

ST-22 Plastic Mounting Profile

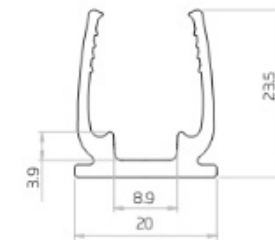

Tolerance: $\pm 0.3\text{mm}$

- 35mm
- 500mm
- 1,000mm
- 2,000mm

Stelline ST-23 Mounting Profiles

ST-23 Serrated Aluminium Mounting Profile

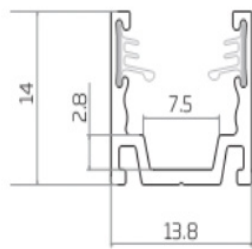
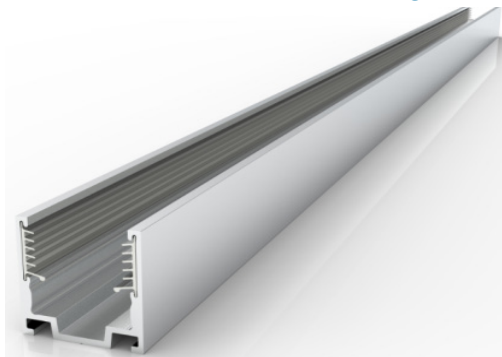

Tolerance: $\pm 0.2\text{mm}$

20mm

500mm

1,000mm

2,000mm

ST-23 Bendable Serrated Aluminium Mounting Profile

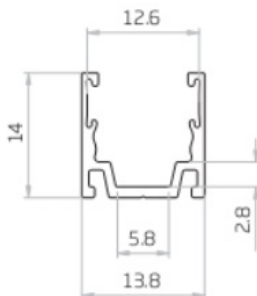

Tolerance: $\pm 0.2\text{mm}$

500mm

1,000mm

Stelline ST-2010 Mounting Profiles

ST-2010 Stainless Steel Mounting Profile

